

Article number: 20171V302SW

Description: E+G

Corner base clamps GN167-V30-2-SW

Measures

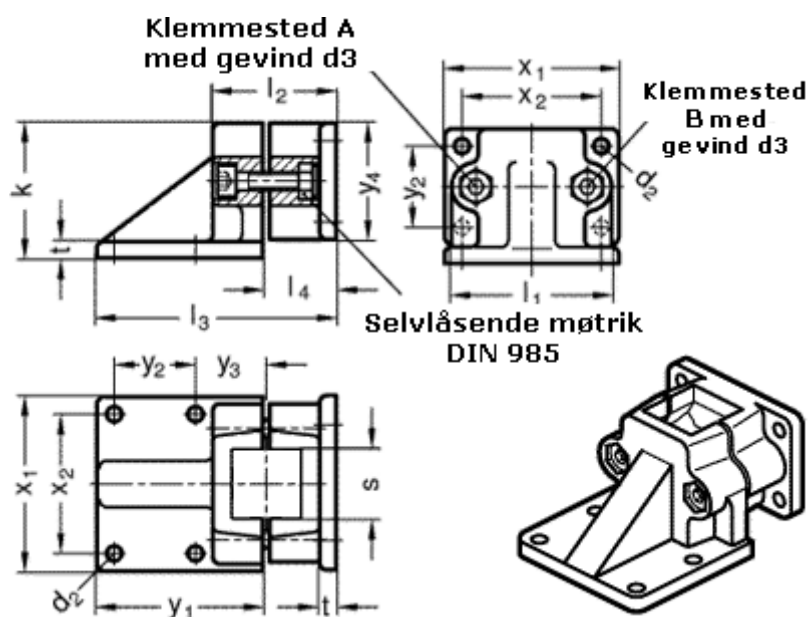

d2 = 7	t = 7
d3 = M 8	x1 = 75
k = 58	x2 = 60
l1 = 69	y1 = 72
l2 = 53	y2 = 35
l3 = 103	y3 = 30
l4 = 30	y4 = 50
S = V30	